

Ventilation: A vital system for a healthy home

All homes require adequate ventilation for the safety of their occupants and to remove excess humidity, airborne pollutants and odors. As homes across the country are built and renovated with energy conservation in mind, they are more air-tight, and the need for balanced mechanical ventilation is even more obvious. Without fresh air, carbon dioxide, odors, dust, airborne pollutants and excess humidity are kept indoors, potentially causing or aggravating problems to occupants' health and comfort, and encouraging mold growth. Clearly, effective ventilation is a vital system in a healthy home. A balanced mechanical ventilation system with heat or energy recovery is an ideal way to meet both building codes and the requirements of many energy efficiency programs such as LEED®, ENERGY STAR® for New Homes, Novoclimat™, BuiltGreen™, R2000 and many more.

Venmar® AVS: Leading the way in indoor air quality technology

For over 30 years Venmar has redefined ventilation by combining innovative technology, expertise and quality manufacturing to offer the most advanced and extensive lines of heat and energy recovery ventilators available. Our HRVs and ERVs will meet the ventilation requirements of practically all builders, remodelers and homeowners across North America.

Venmar AVS units can be installed with multiple air intake and air exhaust grilles so they can revitalize every corner of a home. They can easily be integrated with the existing forced-air system or be installed independently. Venmar AVS is a symbol of quality: all units are HVI and cUL certified and most are ENERGY STAR® qualified. Venmar has been a member of the Home Ventilating Institute (HVI) since 1991, assuring customers that our products meet strict performance standards. Venmar is also a member of the Heating, Refrigeration and Air Conditioning Institute of Canada (HRAI) who offers leadership and training programs for the advancement of its members' business and promotes a code of ethics for consumer protection and safety.

Before choosing a Venmar AVS air exchanger model there are a few things homeowners and builders must consider, such as the importance of maintaining neutral indoor air pressure and how climate plays a crucial role in determining which type of air exchanger will provide the most benefit to a home's indoor air environment.

Equalizing Indoor Air Pressure: A Crucial Balancing Act

It is important not to neglect the impact of an unbalanced ventilation system. If an air exchange unit does not expel and intake equal amounts of air, a negative or positive air pressure imbalance occurs.

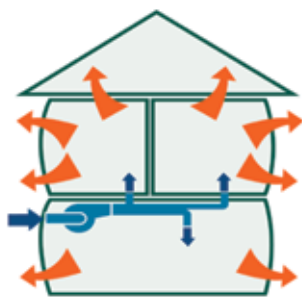

Positive air pressure

- Pushes hot and/or humid air into walls and insulation; condensation can lead to mold, mildew and rot
- Heat loss

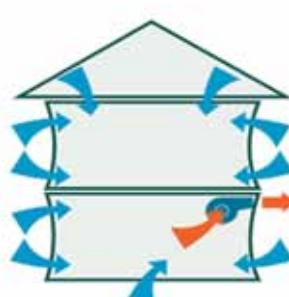

Negative air pressure

- Infiltration of unconditioned air increases risks of mold and higher energy costs
- Potential backdraft from combustion appliances



Equal air pressure

- Supply airflow is equal (CFM) to stale air exhaust
- Balancing is required on all units unless specified otherwise.



Which type of ventilator will respond best to the homeowners' environment? HRV or ERV?

Depending on your home's geographical location, you will need to install one of the following categories of air exchanger: A Heat Recovery Ventilator (HRV) or an Energy Recovery Ventilator (ERV).

HRV - Heat Recovery Ventilator - Ideal for colder climates

In colder climates, where home heating is essential, the heat recovery ventilator (HRV) is the proper choice. The HRV keeps the home supplied with a steady flow of fresh outdoor air. As stale, warm air is expelled, the heat recovery core warms the incoming fresh, colder air before it is distributed throughout the home. The result is a constant supply of fresh air, no unpleasant drafts and greater home comfort. In addition to heat recovery and improved air quality, the HRV provides necessary ventilation while controlling excess humidity.

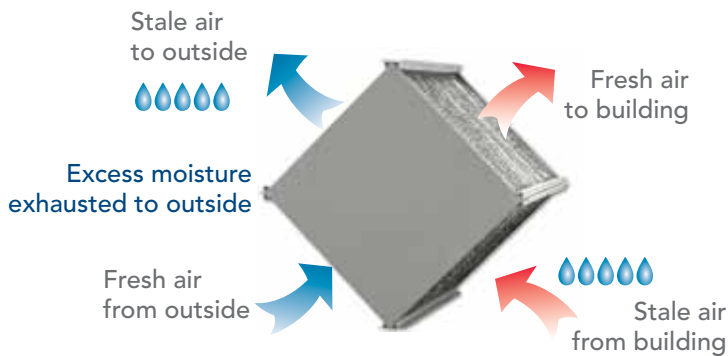

ERV - Energy Recovery Ventilator - Year-round ventilation

ERV's are suitable for all climates including those with hot, humid summers, where homes are air-conditioned and possibly dehumidified during large parts of the year. As the HRV, the ERV recovers the heat in cold season, however, it also recuperates the energy trapped in moisture, which greatly improves the overall recovery efficiency. The ERV process is as follows: In humid climates and air conditioned homes, when it is more humid outside than inside, the ERV limits the amount of moisture coming into your home. In dry climates and humidified homes, when the humidity level is reversed, the ERV limits the amount of moisture expelled from your home.

Heating Season

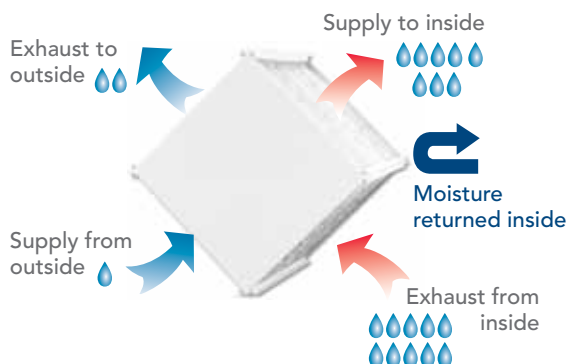

Cooling Season

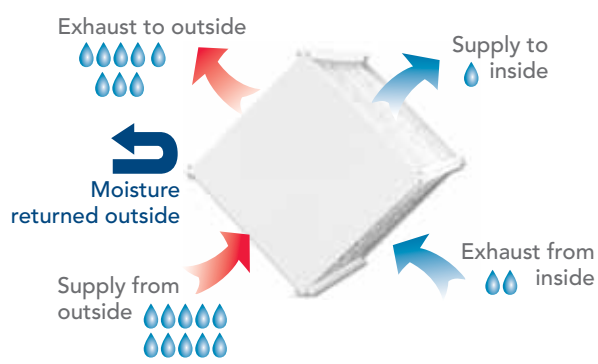

KUBIX

The Ideal Air Exchanger for Small Spaces

Model No. 44102



Model No. 44113

- Ideal for condos, lofts and small homes
- Our lowest priced HRV and ERV
- Fits almost anywhere such as a closet or above a hot water tank
- Available with horizontal or vertical ports (factory-configured)
- Quick and easy to balance and install with integrated hooks and drain fitting, chain and spring kit included
- Optional wall mount bracket available
- Quiet and efficient blower†
- Energy efficient
- Compatible with new Deco-Touch* wall control to maximize home comfort
- 2-year warranty on parts; limited lifetime warranty on HRV core and 5-year warranty on ERV core
- Washable core filters

Deco-Touch Wall Control







Model No. 40395

* Sold separately (refer to p.10 for more details).

† Patent pending.

Kubix Family Specifications

	Model No.	Port location	Port diameter	Rate of air flow (cfm)* (low/high)	Power consumption	Apparent Sensible Effectiveness at 0°C (low speed)	Dimensions (Height) (Width) (Depth)	Weight (approx.)
HRV	44100	Top	4" round (10.2 cm)	35-70	60 W	70%	16 1/4" (41.28 cm) 15 1/2" (39.37 cm) 15 5/8" (39.69 cm)	30 lb (13.6 kg)
HRV Plus	 44102	Top	4" round (10.2 cm)	35-70	60 W	77%	16 1/4" (41.28 cm) 15 1/2" (39.37 cm) 15 5/8" (39.69 cm)	30 lb (13.6 kg)
	 44103	Sides	4" round (10.2 cm)	35-70	60 W	77%	16 1/4" (41.28 cm) 15 1/2" (39.37 cm) 15 5/8" (39.69 cm)	30 lb (13.6 kg)
ERV	 44112	Top	4" round (10.2 cm)	35-70	60 W	77%	16 1/4" (41.28 cm) 15 1/2" (39.37 cm) 15 5/8" (39.69 cm)	34 lb (15.4 kg)
	 44113	Sides	4" round (10.2 cm)	35-70	60 W	77%	16 1/4" (41.28 cm) 15 1/2" (39.37 cm) 15 5/8" (39.69 cm)	34 lb (15.4 kg)

*CFM: at 0.4 inches water (100 Pa). Refer to p.10 for a detailed list of compatible wall controls.

- Ideal for high performance small to mid-size homes
- State-of-the-art ECM motors provide significant electrical consumption savings (67% average compared to standard PSC motors)
- All aspects designed to facilitate air flow balancing and simplify installation
- No drain required for most climate zones (ERV only)
- Upgradable from a heat recovery to an energy recovery ventilator (HRV to ERV) with a simple swap of its core
- Includes fully programmable Altitude wall control offering the Smart mode
- 5-year warranty on parts and core (ERV); limited lifetime warranty on HRV core
- Washable core filters





INCLUDED

Model No. 43910

Model No. 40440

Model No. 43900

EKO Family Specifications

	Model No.	Port location	Port diameter	Rate of air flow (cfm)* (low/high)	Power consumption	Apparent Sensible Effectiveness at 0°C (low speed)	Dimensions (Height) (Width) (Depth)	Weight (approx.)
EKO 1.5 HRV	 43900	Top	oval, fit 6" round (15 cm)	40-80 53-106 66-132 80-157	24 W at 49 CFM 32 W at 81 CFM	83%	24 9/16" (62.4 cm) 23 9/16" (59.9 cm) 14 15/16" (38 cm)	52 lb (23.6 kg)
EKO 1.5 ERV	 43910	Top	oval, fit 6" round (15 cm)	40-80 53-105 67-120 84-140	26 W at 53 CFM 37 W at 84 CFM	73%	24 9/16" (62.4 cm) 23 9/16" (59.9 cm) 14 15/16" (38 cm)	65 lb (29.5 kg)

*CFM: at 0.4 inches water (100 Pa).
Refer to p.10 for a detailed list of compatible wall controls.



Constructo

ERV - HRV - HORIZONTAL - VERTICAL

The most complete line of air exchangers: compact, economical and designed for new construction

Constructo 1.0



Model No. 41500



Model No. 41506

- Ideal choice for small pre-fab and tract houses, condos, apartments and other limited space applications
- Simple to install in a bulkhead or closet
- Available with horizontal or vertical ports (factory-configured)
- Upgradable from a heat recovery to an energy recovery ventilator (HRV to ERV) with a simple swap of its core
- Optimized by the Altitude* wall control, which automatically maximizes home comfort.
- 2-year warranty on parts; limited lifetime warranty on HRV core
- Washable foam filters

* Sold separately.

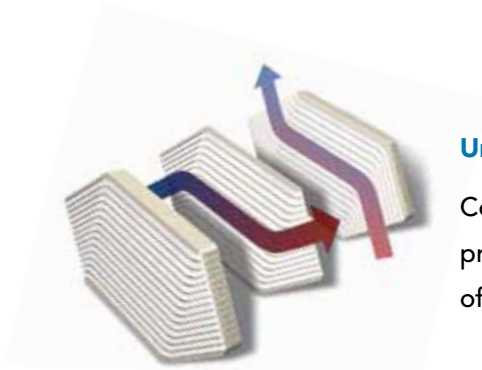

Unique ERV Core (5-year warranty)

Counter cross-flow energy recovery core technology provides the most effective efficiency/volume ratio of all the units of its category.

Models No. 45110

Constructo 1.5 / 2.0



Model No. 43110

- Ideal for mid to large size homes
- Offer effective heat recovery, standard ventilation features to meet codes and standards and quiet operation at a value-conscious price.
- Equipped with a heat recovery core (limited lifetime warranty)
- 2-year warranty on parts
- Washable foam filters







Constructo 1.5V

- Ideal for small to mid-size homes
- Same design as the EKO 1.5 but equipped with 2 PSC motors
- Homeshield™ defrosting system without negative pressure
- Heat recovery core offers greater comfort (limited lifetime warranty)
- 2-year warranty on parts
- Washable core filters



Model No. 43130

Constructo Family Specifications

	Model No.	Port location	Port diameter	Rate of air flow (cfm)* (low/high)	Power consumption	Apparent Sensible Effectiveness at 0°C (low speed)	Dimensions (Height) (Width) (Depth)	Weight (approx.)
1.0 HRV	 41500	Sides	oval, fit 5" round (12.5 cm)	39-98	100 W	76%	12 3/16" (31 cm) 27 1/16" (68.8 cm) 19 13/16" (50.3 cm)	42 lb (19 kg)
	 41502	Top	oval, fit 5" round (12.5 cm)	39-98	100 W	76%	14 11/16" (37.3 cm) 22 9/16" (57.4 cm) 19 13/16" (50.3 cm)	42 lb (19 kg)
1.0 ERV	 41504	Sides	oval, fit 5" round (12.5 cm)	45-108	104 W	79%	12 3/16" (31 cm) 27 1/16" (68.8 cm) 19 13/16" (50.3 cm)	45 lb (20.4 kg)
	 41506	Top	oval, fit 5" round (12.5 cm)	45-108	104 W	79%	14 11/16" (37.3 cm) 22 9/16" (57.4 cm) 19 13/16" (50.3 cm)	45 lb (20.4 kg)
1.5 HRV	 43110	Sides	6" round (15 cm)	64-150	150 W	81%	16 1/2" (42 cm) 35" (89.1 cm) 17 1/8" (43.5 cm)	65 lb (29.5 kg)
2.0 HRV	45110	Sides	6" round (15 cm)	117-189	240 W	81%	16 1/2" (42 cm) 35" (89.1 cm) 17 1/8" (43.5 cm)	67 lb (30.4 kg)
1.5V HRV	 43130	Top	oval, fit 6" round (15 cm)	67-157	125 W	78%	24 9/16" (62.4 cm) 23 9/16" (59.9 cm) 14 15/16" (38 cm)	52 lb (23.1 kg)

*CFM: at 0.4 inches water (100 Pa).
Refer to p.10 for a detailed list of compatible wall controls.



Solo

The Complete Comfort System

Duo

The Year-Round System

Solo 1.5/2.0 & Duo 1.2/1.4/1.9

- Ideal for mid to large size homes
- The Solo family offers a complete solution to reduce excess humidity and expel gaseous pollutants
- The Duo family offers the ultimate heat and moisture recovery offered by ERV's
- Very quiet systems
- Totally reversible units to simplify installation



Model No. 43710



Model No. 43700

Model No. 45700

- Solo's are equipped with a heat recovery core (limited lifetime warranty) and Duo's with a thermal wheel (5-year warranty)
- Optimized by the Altitude* wall control, which automatically maximizes home comfort
- 5-year warranty on parts
- Washable foam filters at time of purchase. Optional pleated, charcoal or electric filters available to boost the filtration level

* Sold separately.

Solo & Duo Family Specifications

	Model No.	Port location	Port diameter	Rate of air flow (cfm)* (low/high)	Power consumption	Apparent Sensible Effectiveness at 0°C (low speed)	Dimensions (Height) (Width) (Depth)	Weight (approx.)
Solo 1.5 HRV	 43720	Sides	6" round (15 cm)	64-150	150 W	81%	16 1/2" (42 cm) 35" (88.9 cm) 17 1/8" (43.5 cm)	65 lb (29.5 kg)
Solo 2.0 HRV	45720	Sides	6" round (15 cm)	117-189	240 W	81%	16 1/2" (42 cm) 35" (88.9 cm) 17 1/8" (43.5 cm)	67 lb (30.4 kg)
Duo 1.2 ERV	43710	Sides	6" round (15 cm)	64-117	160 W	87%	16 1/2" (42 cm) 35" (88.9 cm) 17 1/8" (43.5 cm)	71 lb (32.2 kg)
Duo 1.4 ERV	43700	Sides	6" round (15 cm)	64-120	160 W	80%	16 1/2" (42 cm) 35" (88.9 cm) 17 1/8" (43.5 cm)	71 lb (32.2 kg)
Duo 1.9 ERV	45700	Sides	6" round (15 cm)	117-169	250 W	77%	16 1/2" (42 cm) 35" (88.9 cm) 17 1/8" (43.5 cm)	73 lb (33.1 kg)

*CFM: at 0.4 inches water (100 Pa).
Refer to p.10 for a detailed list of compatible wall controls.

HE 1.8/2.6

- Ideal for mid to large size homes
- Ultimate heat recovery performance and air flow up to 320 CFM
- SilentSure™ quiet operation
- For consumers living in cold climates who seek superior heat recovery performance compared to all other HRV systems on the market
- Optimized by the Altitude* wall control, which automatically maximizes home comfort
- Optional controls allow you to customize unit for enhanced performance
- 5-year warranty on parts; limited lifetime warranty on core
- Washable foam filters



* Sold separately.



Model No. 48400

Model No. 45400

HE Family Specifications

	Model No.	Port location	Port diameter	Rate of air flow (cfm)* (low/high)	Power consumption	Apparent Sensible Effectiveness at 0°C (low speed)	Dimensions (Height) (Width) (Depth)	Weight (approx.)
1.8 HRV	 45400	Top	8" (20 cm) inside ports 6" (15 cm) outside ports	115-197	250 W	95%	42 3/4" (108.6 cm) 23" (58.4 cm) 24" (60.1 cm)	140 lb (63.5 kg)
2.6 HRV	 48400	Top	8" (20 cm) inside ports 6" (15 cm) outside ports	180-321	500 W	94%	42 3/4" (108.6 cm) 23" (58.4 cm) 24" (60.1 cm)	140 lb (63.5 kg)

*CFM: at 0.4 inches water (100 Pa).
Refer to p.10 for a detailed list of compatible wall controls.



Options

Main Wall Controls

Model No.	Description	Compatibility
40395	Deco-Touch (OFF, min/max exchange speed, intermittent 20 min./hour, recirculation, dehumidistat override)	Constructo 1.0, EKO, Solo, Duo, HE, Kubix HRV Plus and ERV
40370	Lite-Touch Constructo (OFF, min/max exchange speed, intermittent 20 min./hour)	All Constructo models, Kubix HRV Plus and ERV
40390	Simple-Touch Constructo (OFF, min/max exchange speed, recirculation)	Constructo 1.0, Kubix HRV Plus and ERV
40350	Constructo (OFF, min/max exchange speed, dehumidistat)	All Constructo models
40310	Venta (OFF, min/max exchange speed, dehumidistat)	Solo, Duo, HE models
40440	Altitude (Programmable, SMART mode, LCD display)	Constructo 1.0 models (August 2008 and later), EKO, Solo, Duo, HE, Kubix HRV Plus and ERV

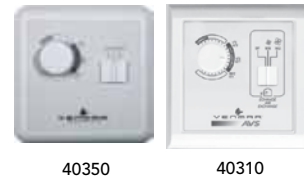

Optional Wall Controls

Model No.	Description	Compatibility
00910	60-min mechanical timer (allows up to 60 min of high speed exchange)	All models
11297	Dehumidistat (24 V / 120 V)	All models
12030	20-min lighted push-button (20-min high speed exchange)	All Constructo and Kubix models
03364	20/40/60-min lighted push-button (20/40/60-min high speed exchange)	EKO, Solo, Duo, HE, Kubix HRV Plus and ERV



Optional Filters - Boost filtration level without risk of contamination

Model No.	Description	Compatibility
03316	Pleated filters (set of 3)	Solo & Duo models
03315	Charcoal filters (set of 3)	Solo & Duo models
03314	Electronic filter (1)	Solo & Duo models

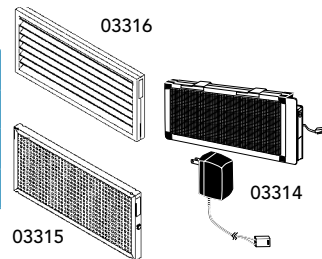

Installation accessories

Model No.	Description	Compatibility
19255	Kubix wall mount bracket kit	All Kubix models
11988	Complete air flow balancing kit with a tool box	All models
14690	Condensed kit (Y-Tandem, complete exterior vent, screws)	Constructo 1.0
14695	Simplified metal installation kit (tandem)	Constructo 1.0

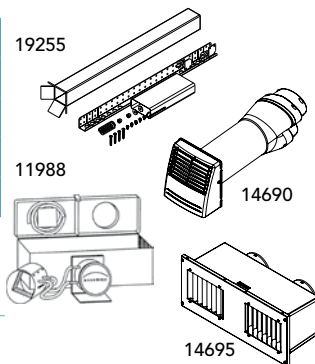

Deco-Touch



Model No. 40395

- Only three buttons for easy use
- Four operating modes: minimum, maximum, intermittent (20 minutes/hour) and recirculation (required by Quebec's Novoclimat™ program)
- Dehumidistat override in response to a preselected indoor humidity level
- Indoor humidity level display and maintenance indicator
- Animated indicators for exchange and recirculation
- LCD screen with blue backlighting activated by the touch of any button

Types of installations

Any Venmar AVS unit can be easily integrated with an existing forced-air system (furnace) as figures 2 & 3 or can be installed independently using the fully ducted system installation (figure 1). Homeowners will be satisfied with multiple air intake and air exhaust grilles that bring exceptional ventilation into every room; not just selected areas. Whatever the installation or ventilation requirements, Venmar AVS has the solution to ensure proper ventilation and better indoor air quality.

Fully Ducted System*

Primarily for homes with radiant flooring, hot water or electric baseboard heating.

Effective because unit captures pollutants at the source and distributes fresh air to living areas.



figure 1

Exhaust Ducted System*

For homes with forced air heating systems or air handlers.

Effective because unit captures pollutants at the source.



figure 2

Simplified*

For homes with forced air heating systems or air handlers.

Easy to install as unit uses existing furnace or air handler ducting.



figure 3

*NOTE: The installation may differ from one unit or home to another.

Constructo 1.0 Installations

Bulkhead Installation

Unique slim design lets you hide unit inside standard 12" bulkheads*. Easily install and access unit through ceiling grille.

* ERV only.



Closet and Utility Room Installation

Compact footprint allows for an easy fit in mechanical rooms, closets or other applications where overall space is restricted.





With more than 30 years of experience and innovation, **Venmar Ventilation Inc.** is the largest manufacturer of air-treatment equipment for the North American residential market with its popular line of range hoods, attic ventilators, ventilation and filtration systems.

Venmar Ventilation Inc.

550 Lemire Blvd.
Drummondville, Quebec
J2C 7W9

Customer Service
Phone: 1-800-567-3855
Fax: 1-800-567-1715

www.venmar.ca